



STEAM PLANET
LUXURY STEAM SHOWER

Owner's Manual
GH-6902



Steam Planet Corporation
22900 Miles Road Cleveland, Ohio 44128
Tel: 216-587-6790 / 1-866-STEAM-61
Fax: 440-348-2336

GH-6902

Contents

1. Preface.....	1
2. Notice.....	1
3. Features of GH-6902.....	3
4. Water and electric connections.....	4
5. Installation.....	5
6. Use.....	6
7. Maintenance.....	7

NOTE: We reserve the right to make changes at any time without notice.

1. Preface

Made of fine-quality materials and equipped with control system, our shower panels provide a perfect bathing solution for the modern style living. Convenience and comfort are just a few characteristics that allow the shower panels to be used everywhere. Whether it is a family home, hotel, or fitness center, our shower panels will help you relax and re-energize.

Our high-quality technologically advanced products meet the international requirements, and are ISO 9000 and ISO 9002 certified.

2. Before you begin

Please take a few minutes to review this manual before you start installation to ensure efficient and safe use of the shower panel.

Any damage caused by improper installation and incompliance with the rules of operation is not covered by the warranty.

This product is for indoors use only.

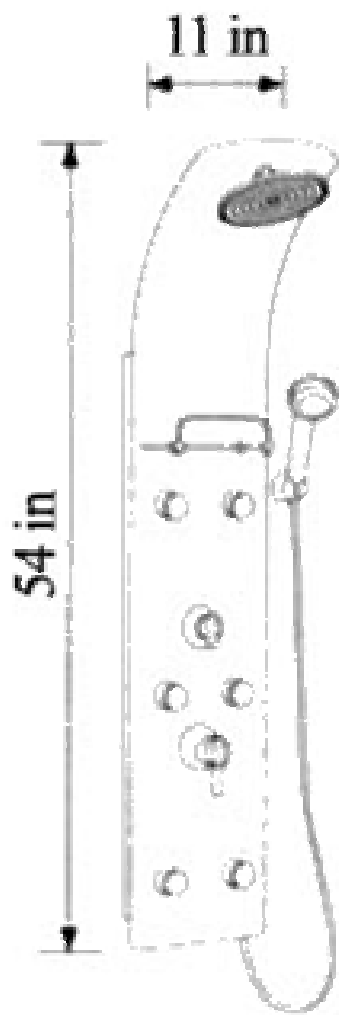

Features of GH-6902

GH-6902 is a multifunctional shower panel. It is specifically designed for easy installation and operation.

GH-6902 shower panel includes:

- hand-held shower head
- overhead shower
- hydro-massage body jets

All components have been tested and carefully selected.

TECHNICAL SPECIFICATIONS AND DIMENSIONS

Model	Water pressure for proper operation	Water flow	Hot & cold water lines	Dimensions	
				L	H
GH-6902	35-70 PSI	2-3 Gal/min	1/2 in	11 in	54 in

Components the GH-6902 model have been tested at the factory and packed separately for convenient transportation.

Carefully unpack and inspect all packages and components. If some parts are damaged or missing notify a distributor immediately.

It is critical that you follow the installation sequence and details in the steps that follow to successfully install and operate your system.

4. Water connection

1. Connect flexible hot and cold water lines with 1/2" screw nuts with hot and cold water supply lines.
2. It is suggested that shutoff valves be installed on both the hot and cold water pipes.
3. Stable water pressure of between 35 and 75 PSI is required for proper operation.
4. To avoid scalding, hot water supplied should be below 50°C.

Technical specifications:

Hot and cold water pipe: pipes with 1/2 " screw thread outer. Extrude 1.5in out of the wall; a valve for each of the hot and cold water pipe is suggested.

The distance from the top of the shower panel to the floor should be 85 in.



Cold & Hot Pipes

5. Installation

Hang the shower panel, adjust it as needed. Make sure it is positioned vertically.



Parts

Place flat wall hanger on area of wall where it will be fixed and mark. Use screw bolts that are supplied and screw them through wall plate to secure it to the wall. Hang wall shower panel on wall hanger and level the shower panel.



Hanging bar



Brackets

6. Use

1. Using the hand-held shower head

1.1 The hand-held shower head of GH-6902 shower panel.

Select the 'shower position' using the selector knob.

Pull up the temperature adjusting handle and turn it right or left to achieve the desired water temperature.

2. The fixed overhead shower

2.1 The fixed overhead shower of GH-6902 shower panel.

Select 'overhead shower head' position using the selector knob.

Pull up the temperature adjusting handle and turn it right or left to achieve the desired water temperature.

Hold the fixed overhead shower head and turn it right to the ON position.

PAGE 7

Pull up the temperature adjusting handle and turn it right or left to achieve the desired water temperature.

2.3 The fixed shower head can be adjusted up to 15° in any direction.

3. Using the hydro-massage jets.

3.1

Select 'massage nozzle' position using the selector knob.

Pull up the temperature adjusting handle and turn it right or left to achieve the desired water temperature.

4. Turn on water

Use only with GH-6902 shower panel.

For running water, select 'turn on water' position using the selector knob.

Pull up the temperature adjusting handle to turn on the water.

7. Maintenance

Maintenance is an integral step in the system's proper functioning.

Keep the shower panel clean and tidy.

Clean the shower panel with soap.

Do not use acetone or ammonia.



22900 Miles Rd., Cleveland, OH 44143
(216) 587-6190 ▪ Fax: (440) 348-2336
(866) STEAM-61 ▪ info@steamplanet.com